

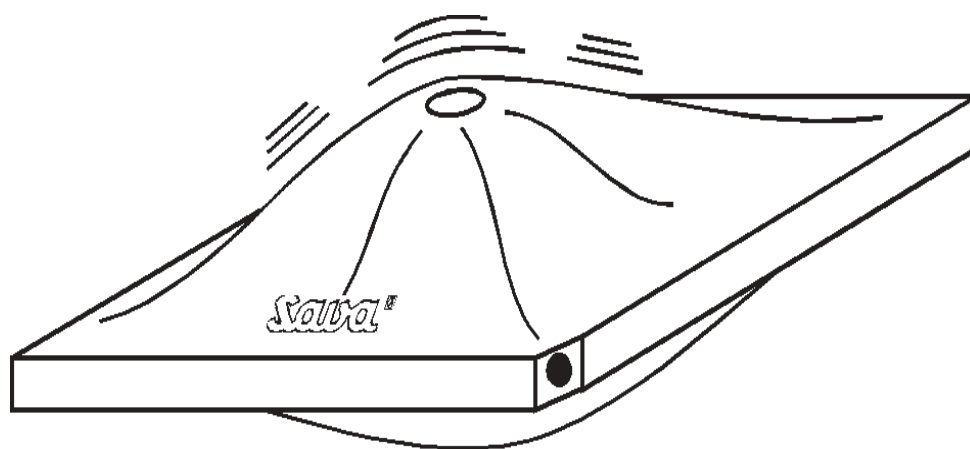

# LIFTING AIR BAGS

## MANUAL INSTRUCTIONS





## WARNING!

Before using the air bag, carefully read these instructions. Non considering can result in various damages.

- Never work under a load without safety supports
- Never exceed the inflation pressure of 8 bars ( 118 psi )
- Never place more than 2 air bags one upon another (Except when using Flat-Form bags).

### Information

This booklet contains technical information about lifting air bags and basic instructions for use. The selection and application of an air bag depend on various factors such as lifting requirements, capacity, lifting height, shape of objects. The manufacturer doesn't assume any responsibility for personal injuries or material damages arising from improper use or misuse of lifting air bags and their constituents. The figures beside the text are shown for information only. Actual conditions of lifting techniques and characteristics depend on particular application and are from case to case different.

### Recommendations for safe and efficient work

When using air bags, always wear protective clothing. Firemen and rescue-team members must be equipped completely in accordance with the requirements, other users should wear safety helmet, safety glasses and gloves or other equipment if required.

Proper transportation of air bags is of great importance. Care should be taken that air bags are always being carried with the inflation nozzle facing upwards to avoid damaging it in case of an air bag's falling down. Air bags of great sizes and weights are to be carried by two persons. When air bags are stored or transported in horizontal position, the inflation nozzle must face ahead so that it can be easily seen when an air bag is to be moved, and that the work can be done safely without risk of damage.

When the surface temperature of the object to be lifted exceeds 55°C, the part of the air bag in contact with the object is to be protected by means of a fibreboard. Heat and temperatures exceeding the permissible level can damage the air bag.

Even though it is simple to place and to inflate the air bag, the operation in dark is dangerous. The work place is to be well illuminated. Sometimes, when due to the affect of shading the visibility is poor, even during the day it is reasonable to use additional sources of light.

### How does the inflation system operate

Prior to use the air bag, set the pressure to 0,8 Mpa ( 8 bar, 118 psi ) using the pressure reducing valve. The two filling valves on the double controller are to be closed. Connect the air bag to the distribution pipes and set it to the correct lifting position. Open left or right filling valve on the double controller. By means of a pressure gauge check the working pressure and the air bag operation at inflation. After concluding the operation of lifting or separating, close the filling valve on the controller (Figure 1). To let off the air open the safety valve on the double controller. Remove the air bags from the site of use, disconnect them, load them to press out the remaining air, and clean them.

When using SAVA lifting bags always observe the combination of controller – inflation hose - lifting bag in order to prevent exceeding the permissible inflation pressure. Never avoid the controller and connect the pressure reducer directly to the lifting bag. Controllers are equipped with safety valves and pressure gauges, which are calibrated to the corresponding pressure area.



The controller pressure gauges indicate the internal pressure in the lifting bags and possible incorrect inflation procedure. Inflation hoses are of different colours to simplify the connection to the controller.

The inflation hoses are equipped with couplings with double guards. They open only if the male part of the coupling is drawn and the protecting ring of the female part pulled back simultaneously. (see illustration)



### Air supply

Any air source not exceeding the relative test pressure (12 bar) may be used to inflate the lifting bags. If the inflation pressure exceeds 12 bar, a pressure reducer should be applied.

The lifting bags may be activated also by the inflation pressure lower than 8 bar. In this case it is not possible to reach the maximum lifting capacity. If compressed air contains oil, use oil separator.

### Use of compressed-air bottle, 200 or 300 bar

Connect the pressure reducer by a threaded nipple to the compressed-air bottle. By turning a regulating screw (C) on the pressure reducer shut the air outlet. Open the compressed-air bottle valve (A); the pressure gauge (B) indicates the pressure in the bottle.

By a regulating valve (D) adjust the outlet pressure to the value of 10 to 12 bar, which is shown on the pressure gauge (E); repeatedly open (C).

It is important to connect the air supply hose on the pressure reducer with the controller. Insert the male part into the female part and press the protecting ring to be in mesh.

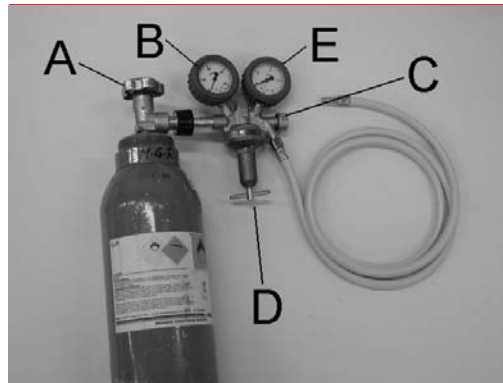

### Lifting bags with a controller, equipped with a gate valve

Connect the controller by the air supply hoses with the lifting bags (different colours).

Insert the nipple (A) in the female part of the coupling with a double guard and press to be in mesh.

Connect the air supply from the compressed-air bottle with the controller.



If you use any other compressed-air sources adjust the inlet pressure to the maximum of 12 bar or use pressure reducer.

Inflate the lifting bags by pulling the lever (A) on the controller.

Check the pressure gauges (B), which indicate the achieved pressure in the lifting bags.

When the required height or the maximum relative operating pressure of 8 bar is reached, interrupt the inflation by releasing the lever.

The lever automatically returns to the neutral position (position of safety guard).

If the pressure in the lifting bag exceeds 8 bar, it is automatically released by the safety valve.

Use the lever (A) for deflating the bag or lowering the load.

When lifting procedure is finished and load fixed, shut the regulating valve (D) on the pressure reducer.

Release the inflation hose pressure by quickly pushing the lever.

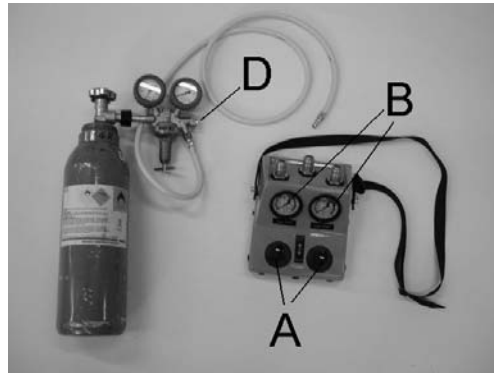
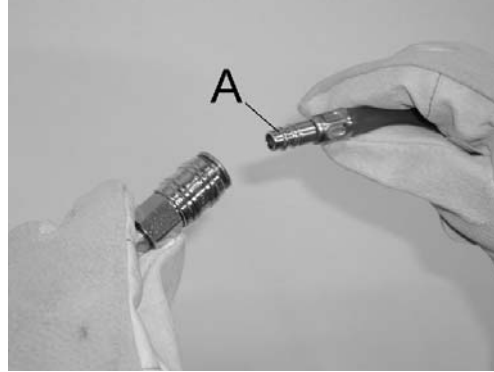

#### Lifting bags with a single or double controller

Use air supply hoses of different colours to connect the single or double controller with one or more lifting bags.

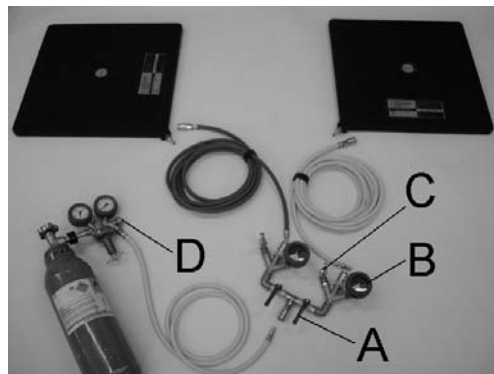



Insert the part (A) in the coupling with a double guard and press to be in mesh.

Observe the above instructions and connect the compressed-air supply from the compressed-air bottle with a controller.

If other sources of compressed-air are used, adjust the inlet pressure to the maximum of 12 bar or use pressure reducer.

Inflate the lifting bags by opening the ball valve (A) on the controller.

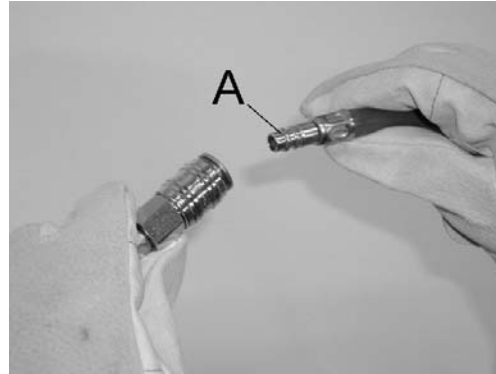

Check the pressure gauges (B) that indicate the pressure in the lifting bag, and the load.

When the required height or maximum relative operating pressure of 8 bar is reached, interrupt inflating by shutting the ball valve (A).

If the pressure in the lifting bag exceeds 8 bar, it is automatically released by the safety valve.

When the lifting procedure is completed and the load fixed, shut the regulating valve (D) on the pressure reducer.

Release the pressure in the air supply hose by quickly opening the ball valve (A).

If you wish to empty the bag or lower the load, turn the outlet valve left.

#### **Use of other compressed-air sources**

There are various adapters available for applying other sources of compressed-air.

If the maximum pressure of compressed-air exceeds 12 bar, use the pressure reducer and reduce the pressure to approximately 12 bar.

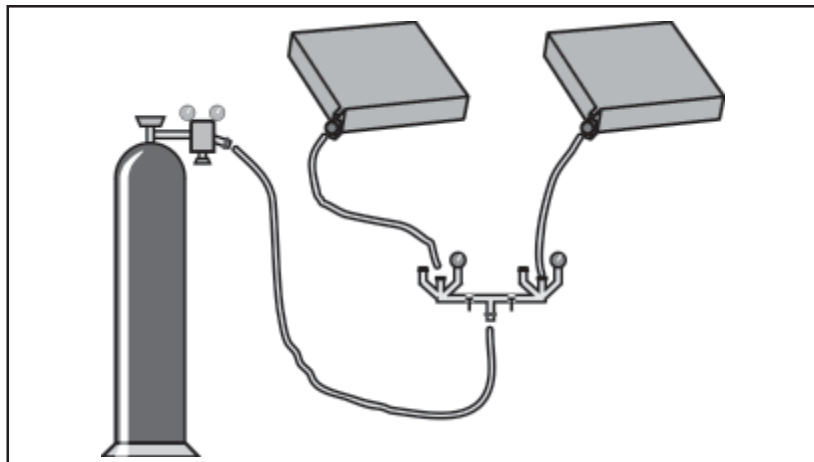
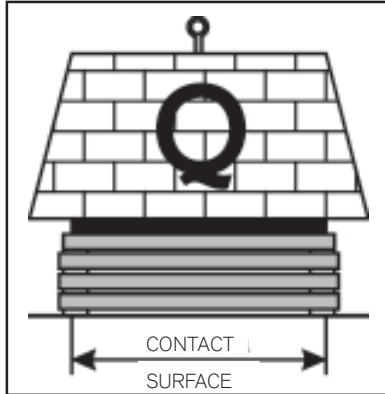
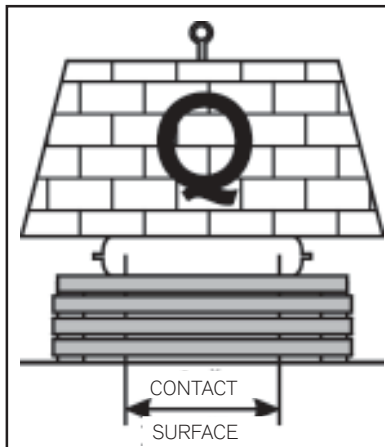

Figure 1



Position the air bag on a prearranged place or a constructed foundation (Figure 2). Fully emptied air bag contains very little air.

Figure 2



During the process of air bag inflation, the air column and consequently the lifting height are increasing, while the contact surface between the bag and the object is decreasing, resulting in decreasing lifting capacity (Figure 3). Thus, maximal force can be attained only at the beginning of inflation, when the lifting height is minimal. During the inflation, the air bag is gradually getting a characteristic spherical form (see enclosed diagrams).

Figure 3

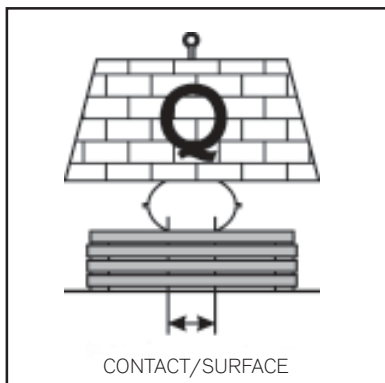

With the air bag fully inflated, the contact surface and lifting capacity reach their minimum, and the lifting height its maximum (Figure 4). To be able to correctly operate the air bag, a user must be acquainted with the data about maximal lifting force, maximal lifting height and maximal lifting capacity at maximal lifting height.

Figure 4



### Lifting using a single air bag

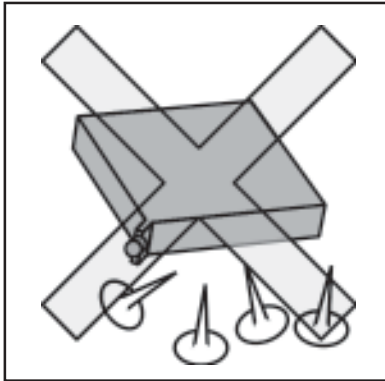

1. The place where the air bag is intended to be positioned on, is to be cleaned of glass fragments and other foreign particles which might damage the air bag. When the air bag is to be put on a surface, presenting - due to oily spots or ice - to the air bag the risk of slipping the surface is to be covered with sand or any other granulated material. When the air bag is used on a not firm and soft ground, a solid support or a fibreboard is to be arranged under the air bag (Figure 5).

Figure 5

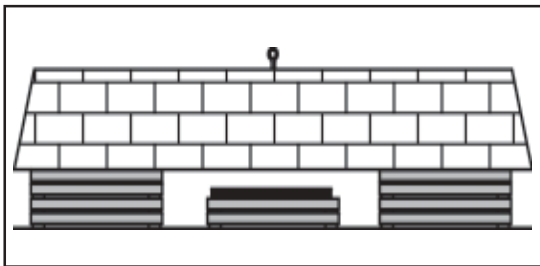

2. When there is more than 70 mm space between the ground and the object to be lifted, a firm, high enough foundation is to be built, leaving just enough space to insert a non inflated bag. The upper surface of the foundation should be undivided, without any gap, thus preventing the air bag from collapsing during inflation (Figure 6).

Figure 6

3. On each side of the air bag foundation, additional safety supports are to be built, extending to the point which doesn't permit another insertion (Figure 6). This reduces the height, from which the object of lifting would fall in case of an eventual loss of air in the air bag or if the inflation system breaks down.
4. The air bag is to be inserted in the middle of the foundation so that the inflation nozzle is pointed right or left from the object to be lifted. Always make sure that the air bag surface lays against the lower surface of the object. A too small contact surface can cause the object to slide during the inflation, as the inflated air bag would considerably displace from the object to be moved.

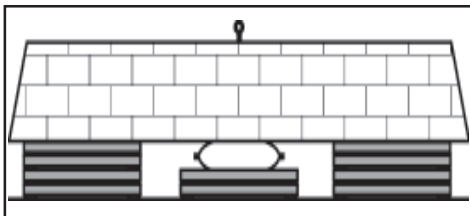

5. Inflate the air bag to achieve the required height, then add safety supports as high as possible (Figure 7). Provided that sufficient staff is available, the safety supports are recommended to be built simultaneously with the air bag inflation.

Figure 7

6. Slowly empty the air bag, allowing the object to lay safely upon the safety supports. Remove the air bag and the foundation if the required working area is located under the lifting point.



## WARNING!

At any lifting operation, the safety supports are of essential importance. Any work under a load supported only by an inflated air bag is strongly forbidden.

### Lifting using two air bags

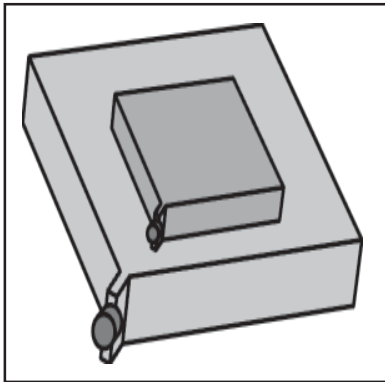

In order to increase lifting height, we can use two air bags, placing the smaller one in the middle of the greater one, with the inflation nozzles pointed away from the object to be lifted, each one to the other side, right or left (Figure 8). Never put more than two air bags one upon another.

Similarly to the lifting with a single air bag, it is necessary to construct a foundation.

Figure 8

First inflate the lower, greater air bag, so as to allow the smaller one to touch the object to be lifted. Then fully inflate the upper air bag and, if necessary, the lower one again, until the required lifting height is achieved.

Safety supports are to be added under the load with care. After concluding the inflation, slowly empty the air bags.

### Increasing lifting capacity and height

It is wrong to believe that lifting capacity can be increased by placing air bags one upon another. With a bloc of two air bags one upon another, we only increase lifting height, while lifting capacity of the bloc is the capacity of the small air bag (Figure 10). Lifting capacity depends on the size of the air bag surface in contact with the lower surface of the object to be lifted.

Lifting capacity (kg) = bag internal pressure (bar) x active contact surface (cm<sup>2</sup>)

Due to the increasing convexity during the lifting procedure the contact surface between the bag and the load grows smaller. Thus the lifting capacity decreases in proportion to the increase of lifting height. In order to choose a proper size of the bag consider the graph that shows the lifting capacity depending on the lifting height, if the internal pressure of the bag is 8 bar.

If the lifting height cannot be defined, select the largest air bag available and suitable to be placed under the load.



Thus, lifting capacity can only be increased by placing one air bag beside another, provided that both are being inflated simultaneously.

Figure 9 shows two air bags, placed one next to the other on foundations. The first air bag can lift 8 tons, the second 12 tons. Neither of the bags can lift the load of 15 tons. However, when being inflated together, they are able to lift even 20 tons, and consequently, using this bloc, the load of 15 tons can be lifted.

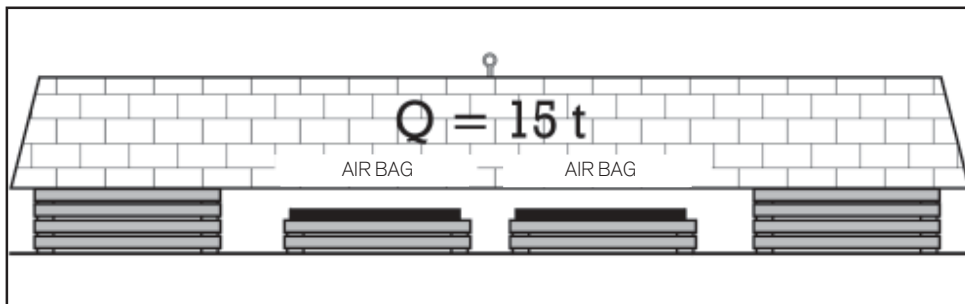

Figure 9

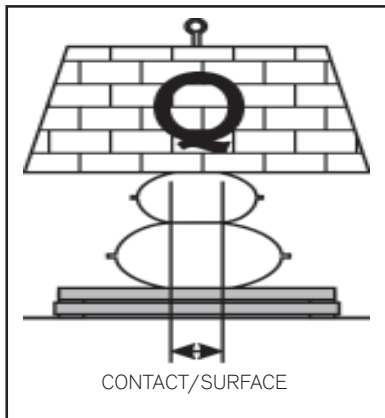

Figure 10

Lifting height can be increased by placing one air bag upon another (Figure 10). If the lifting height of one bag is 18 cm max and of the other 22 cm, both together and fully inflated can achieve the lifting height of 40 cm.

### WARNING!

Never put more than two air bags one upon another.  
By constructing supports we can achieve topmost lifting heights and capacities.



### Lifting the objects of unusual forms

#### Lifting a profile or a hose

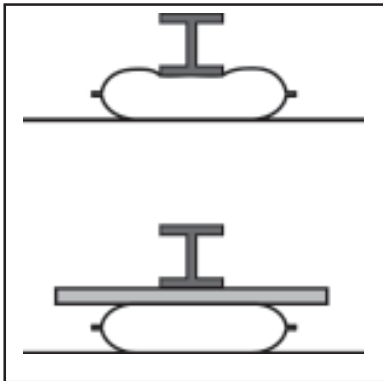

At lifting a profile or a hose using an air bag, problems arise as the object doesn't contact the entire surface of the bag. Further, a steel or kevlar cord can be damaged by twisting.

For that reason a fibreboard is to be inserted between the air bag and the object to be lifted, in order to permit the lifting force to be equally distributed over the entire lifting surface of the air bag (Figure 11).

Figure 11

#### Lifting a cylindrical object

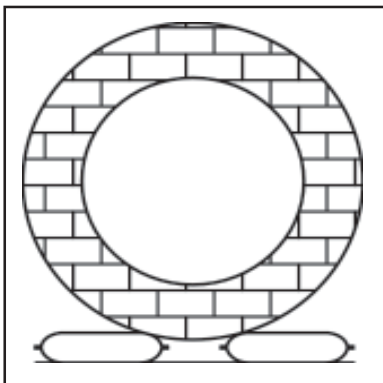

Cylindrical objects of great size such as tanks don't admit lifting by a single air bag. If such object is not firmly fastened it shall roll away as soon as the air bag begins extending to get its typical spherical form.

For that reason cylindrical objects are to be lifted using two air bags, one at each side of the object. The air is to be supplied so as to permit equal, co-ordinated lifting (Figure 12).

Figure 12

#### Separating and pushing, using air bags

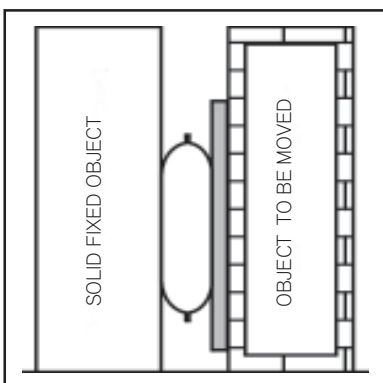

Air bags can also be used to separate and to move objects, usually without special difficulties. Problems arise if an object has thin walls which could be bent or broken by the pressure of the air bag. For that reason the air bag is to be reclined against a rib, a pillar or another tough and rigid element. If this is not possible, insert a wide fibreboard between the air bag and the object to increase the surface the pushing force shall act upon (Figure 13).

Figure 13



### Cleaning after use

Each time after use air bags are to be cleaned. Oil or grease spots can cause air bags to slide, the presence of dirt in the nozzle disable the connection of pipe. In the upright position with the nozzle at the top, the air bag is to be knocked against the floor to shake off the dirt. Check the opening in the nozzle. If it is full of dirt, remove it using a thin piece of wire. Don't push the dirt inside the bag but draw it out.

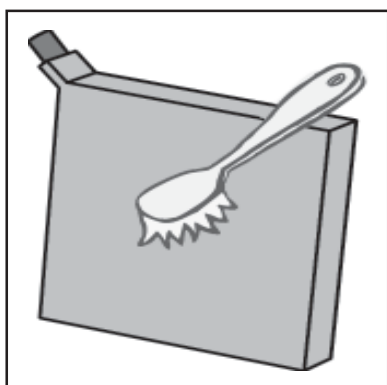

To remove agglutinated dirt from the air bag surface, use a brush with hard bristles. Move the brush in all directions. Don't use sharp objects to remove dirt from the air bag surface.

After cleaning all the agglutinated dirt, soak the spots with a light solution of warm water and a detergent to wash the dishes, and using the brush, remove the remaining dirt (Figure 14).

Figure 14

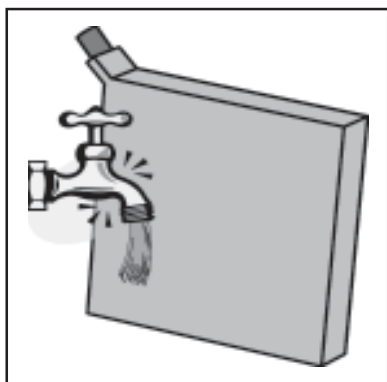

Rinse the surface with cold, fresh water (Figure 15). Strong water jet shall remove all the dirt and detergent which might have remained on the air bag surface.

With the air bag in the upright position, wipe the nozzle using a clean cloth. Let the air bag dry. Don't speed up drying by putting the air bag in a drier or close to a source of heat.

Figure 15

### Checking, storage and preventive maintenance

Adequate maintenance and care for air bags require more than cleaning after use. Air bags call for inspection, and preventive maintenance throughout the period of storage.

Check after use

1. When dry, check the air bag for eventual air blisters, notches or worn out segments that might be hidden under the dirt. If you observe any damage or defect, mark it with a chalk, and consult the manufacturer or an authorised service.
2. Check the nozzle for any damage which could disable the connection. Replace the nozzle, if necessary.



#### Storage

- When air bags are stored in vertical position, their nozzles must face the user, so that when handling and using the bags again, he would be able to protect the nozzles by hand to prevent them from damaging.
- When air bags are stored in horizontal position, their nozzles must face the user alike, in order to eliminate the possibility of their rubbing against the wall or another object when the air bags shall be next handled and used.

#### Preventive maintenance

Provided that an adequate care is taken of the air bags and that they are properly stored, there is practically impossible for the air bags and the inflation system to fail in a critical moment. Periodically check all the segments essential for operation, and clean them; wipe metal parts using a soft cloth. If you observe any damage of vital importance for the air bag's functioning, chalk it and consult the manufacturer or the nearest authorised service.

#### Sequence of check-ups:

- visual and operating check-up
- check-up of air supply hoses couplings
- check-up of safety valves, couplings and pressure gauges on controllers
- check-up of pressure reducer operation
- check-up of lifting bag nozzles

After every use carefully inflate the air bag. Start with the pressure of 0.5 bar and check for damages. If there are no damages visible such as holes or cuts, increase the pressure to 4 bar maximum and repeat the visual check-up.

In case of holes or cuts, through which the armature is visible, the air bags should be put out of operation. Due to safety reasons repair of such air bags is not allowed.

When the repair is allowed, it may be performed only by a manufacturer's representative or its authorized person, who at the same time checks and tests the air bag after repair. In this way a further safe use of the air bag is assured.

#### Service life

Air bags are made from rubber and therefore exposed to ageing. Although the visual check-up shows that the bag is in good condition, it should be put out of operation after 15 years, for the material construction itself is exposed to ageing.

### Elimination of defects

#### Damaged air bag nozzles

Damaged nozzles can be replaced. By means of a corresponding key unwind the nozzle and be careful not to move the threaded part. Fix a new nozzle in the same way.

#### Frozen air bag nozzles

If the temperatures fall below zero and the air is humid and cold, ice could appear in the nozzle. Use a quick defrosting spray or manually warm the nozzle. Wear protective gloves.

#### Foreign bodies

Remove foreign bodies from the nozzle by an edgeless wire.



If you cannot eliminate the problem contact the manufacturer's authorised person or the manufacturer.

#### Periodical check-ups

The manufacturer checks every lifting bag 100 per cent. Periodical check-ups of lifting bags are required for safety reasons.

Every lifting bag is enclosed a periodical test sheet with the instructions for performing periodical check-ups, which also serves as a document about performing periodical checks.

Periodical check-ups may be carried out by a representative of the manufacturer, or any other person authorised by the manufacturer.

### PROCEDURES FOR PERFORMING PERIODICAL CHECK-UPS

1. FILL THE AIR BAG WITH WATER TO REACH THE PRESSURE OF 8 BAR AND LET IT UNDER PRESSURE FOR AT LEAST TEN (10) MINUTES, THEREBY CHECKING ALL DETAILS. FINALLY FILL OUT THE PERIODICAL TEST SHEET.

#### LEAK TEST

Any leakage from the bag or the connection that causes the fall of internal pressure in the bag, signals a serious damage to the air bag.

Every bag should hold water supplied under the pressure of 8 bar without leaking.

2. VISUAL CHECK-UP

#### VISIBLE IMPRESSION

Cord threads from the steel or Kevlar reinforcement may not protrude on the surface of the air bag. In case of visible cord threads these should be completely anew rubberised. Visible imprints are only acceptable, if rubber cannot be removed by a fingernail, meaning that the rubber thickness is adequate.

#### FOREIGN BODIES ON SURFACE

Smaller foreign bodies may only be removed from the surface of the air bag, if they do not damage the surface on more than (1''<sup>2</sup>) square inch (25 x 25 mm) and if not too deep imprinted in the surface. Only smaller fabrics are allowed, while larger pieces of paper, stones etc. can change or affect the contact surface of the air bag. Such air bag should be immediately put out of operation.

#### BOILS

Boils that spoil the appearance and aggravate the efficiency of the air bag are not allowed. Only boils with characteristics as stated below are allowed on condition that their position does not affect the capacity, safety or efficiency of the product.

- a. firm, with a dia of less than 1/8 inch or 6.35 mm
- b. firm, 2 inches or 25.40 mm long and 1/8 inch or 3.175 mm or less long
- c. firm, protruding from the surface less than 1/6 inch or 1.587 mm.

Soft and porous boils, bulges under a label, are not allowed.

#### CRACKS

Cracks more than 1/32 inch or 0.794 mm wide and up to 1/32 inch or 0.794 mm deep with a visible edge, and up to 4 inch or 101.60 mm long are acceptable, if their position does not affect the properties and safety of the product, otherwise not.



#### BLISTERS

Blisters are areas with soft edges and spongy to touch. Blisters are boils inside the air bag and do not spoil its appearance. If the feature exceeds the safety limits, the product is not acceptable.

#### PLY SEPARATION

Visible ply separations are not acceptable. If the air bag armature contains a boil or a void, the bag should be rejected. If anywhere in the bag air or water remains captured, the bag should be put out of operation.

#### PLY INTERLACING

Acceptable, if it does not affect the capacity, safety and use of the product, even if wrinkles or uneven surface appear. If interlacing is too excessive, the bag should be rejected.

#### FOLDS ON BAG EDGES UNDER PRESSURE

Depth: a fold on the edge is acceptable if its depth does not exceed  $3/8$  inch or 9.525 mm.

Width: a fold on the bag is acceptable, if its width does not exceed  $3/8$  inch or 9.525 mm. It may appear only on one or two spots on the bag.

#### 3. STORING

Completely deflate the bag, check the inflation nipple and inside threads and possible damages. Clean the bag and store it properly.

#### INFLATION NIPPLE

The brass nipple may not be broken, cut or have damaged threads.

#### DAMAGED THREAD

If the nipple is not suitable or the thread damaged, the bag should be rejected.



## TECHNICAL DATA FOR AIR BAGS

High-pressure air bags, Kevlar-reinforcement

Table - Kevlar

<b>Kevlar Reinforced Air Bags</b>												
Model	EU USA	SLK 1/7 1,1/2,8	SLK 3/13 3,5/5	SLK 6/15 6,8/6	SLK 8/18 8,8/7	SLK 12/22 13,3/9	SLK 19/27 21/11	SLK 24/30 26/12	SLK 31/36 34/14	SLK 40/42 44/17	SLK 54/45 59/18	SLK 64/51 70/20
Art.No.		77973	77974	77975	76734	76735	76736	76737	76738	76739	76794	76740
Size	cm x cm in. x in.	15 x 15 6 x 6	22,5 x 22,5 9 x 9	30 x 30 12 x 12	38 x 38 15 x 15	45 x 45 18 x 18	55 x 55 22 x 22	61 x 61 24 x 24	69 x 69 27 x 27	78 x 78 31 x 31	87 x 87 35 x 35	91 x 91 36 x 36
Thickness	mm in.	28 1,1	28 1,1	28 1,1	28 1,1	28 1,1	28 1,1	30 1,2	30 1,2	30 1,2	30 1,2	30 1,2
Weight	kg lb	0,6 1,32	1,3 2,9	2,4 5,3	4,0 8,8	5,3 11,7	8,1 17,9	11,2 24,7	13,3 29,3	18,2 40,1	22,5 49,6	25,3 55,8
Insertion height	mm in.	29 1,15	29 1,15	29 1,15	29 1,15	29 1,15	29 1,15	31 1,22	31 1,22	31 1,22	31 1,22	31 1,22
Max. lifting height	cm in.	7 2,8	13 5,1	15 5,9	18 7,1	22 8,7	27 10,6	30 11,8	36 14,2	42 16,5	45 17,7	51 20,1
Max. lifting capacity	kg UST	1050 1,16	3040 3,35	6050 6,7	8700 9,6	12800 14,1	20000 22,0	25080 27,6	32200 35,5	42050 46,4	53800 59,3	63700 70,2
Nominal content	L Cfeet	0,6 0,02	1,7 0,06	4,7 0,17	9,6 0,34	16,9 0,60	32,9 1,16	46,2 1,63	69,0 2,44	102,3 3,61	145,0 5,12	167,2 5,90
Max. air requirement	L Cfeet	5 0,18	15 0,53	42 1,48	86 3,04	152 5,37	296 10,45	416 14,68	621 21,92	921 32,51	1305 46,07	1505 53,13
Max. inflation pressure	bar PSI	8 116	8 116	8 116	8 116	8 116	8 116	8 116	8 116	8 116	8 116	8 116
Test pressure*	bar PSI	12 174	12 174	12 174	12 174	12 174	12 174	12 174	12 174	12 174	12 174	12 174
Bursting pressure*	bar PSI	>32 >464	>32 >472	>32 >472	>32 >472	>32 >472	>32 >472	>32 >472	>32 >472	>32 >472	>32 >472	>32 >472

High-pressure air bags, steel-reinforcement

Table – Steel

<b>Steel Reinforced Air Bags</b>									
Model	EU USA	SLS 8/18 8,8/7	SLS 12/22 13,3/9	SLS 19/27 21/11	SLS 24/30 26/12	SLS 31/36 34/14	SLS 40/42 44/17	SLS 54/45 59/18	SLS 64/51 70/20
Art.No.		76741	76742	76743	76744	76745	76746	76795	76747
Size	cm x cm in. x in.	38 x 38 15 x 15	45 x 45 18 x 18	55 x 55 22 x 22	61 x 61 24 x 24	69 x 69 27 x 27	78 x 78 31 x 31	87 x 87 35 x 35	91 x 91 36 x 36
Thickness	mm in.	28 1,1	28 1,1	28 1,1	30 1,2	30 1,2	30 1,2	30 1,2	30 1,2
Weight	kg lb	5,5 12,1	7,6 16,8	11,6 25,6	15,7 34,6	19,3 42,5	25,0 55,1	31,0 68,3	35,0 77,2
Insertion height	mm in.	29 1,15	29 1,15	29 1,15	31 1,22	31 1,22	31 1,22	31 1,22	31 1,22
Max. lifting height	cm in.	18 7,1	22 8,7	27 10,6	30 11,8	36 14,2	42 16,5	45 17,7	51 20,1
Max. lifting capacity	kg UST	8700 9,6	12800 14,1	20000 22,0	25080 27,6	32200 35,5	42050 46,4	53800 59,3	63700 70,2
Nominal content	L Cfeet	9,6 0,34	16,9 0,60	32,9 1,16	46,2 1,63	69,0 2,44	102,3 3,61	145,0 5,12	167,2 5,90
Max. air requirement	L Cfeet	86 3,04	152 5,37	296 10,45	416 14,68	621 21,92	921 32,51	1305 46,07	1505 53,13
Max. inflation pressure	bar PSI	8 116	8 116	8 116	8 116	8 116	8 116	8 116	8 116
Test pressure*	bar PSI	12 174	12 174	12 174	12 174	12 174	12 174	12 174	12 174
Bursting pressure*	bar PSI	>32 >472	>32 >472	>32 >472	>32 >472	>32 >472	>32 >472	>32 >472	>32 >472



### Lifting capacity in dependence on lifting height

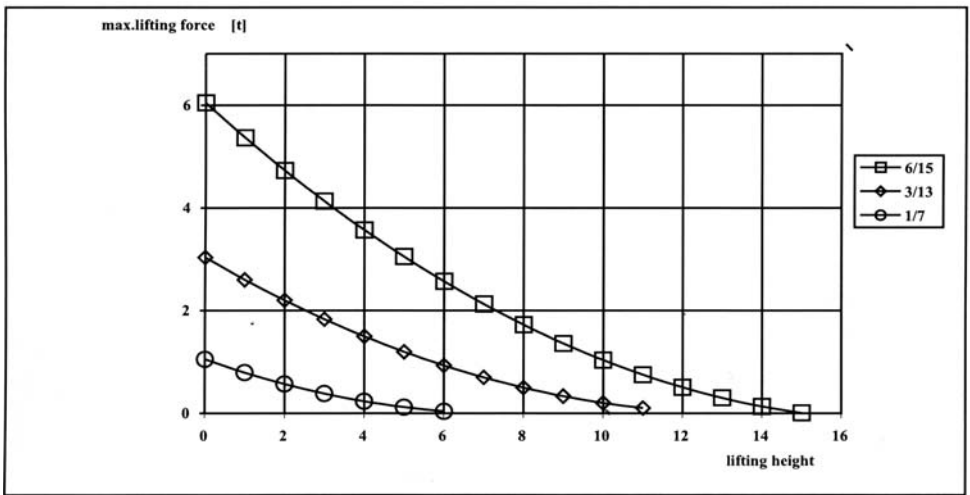
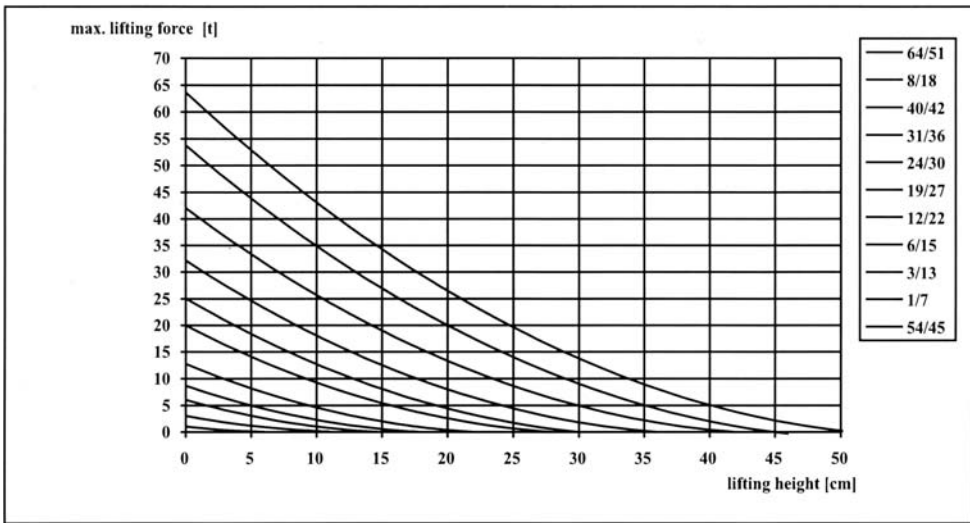



**PERIODICAL CHECK-UP LIST FOR AIR BAGS**

**AIR BAG 8 bar**

TYPE:

SERIAL NO.:

**YEARS FROM PURCHASE**

	5	7	9	11
A. Leak test air bag:	<input type="checkbox"/> ok	<input type="checkbox"/> ok	<input type="checkbox"/> ok	<input type="checkbox"/> ok
- valve	<input type="checkbox"/> ok	<input type="checkbox"/> ok	<input type="checkbox"/> ok	<input type="checkbox"/> ok
B. Visual check:				
- no surface irregularities	<input type="checkbox"/> ok	<input type="checkbox"/> ok	<input type="checkbox"/> ok	<input type="checkbox"/> ok
- no irregularities on edges	<input type="checkbox"/> ok	<input type="checkbox"/> ok	<input type="checkbox"/> ok	<input type="checkbox"/> ok
- no irregularities on air inflation nipple	<input type="checkbox"/> ok	<input type="checkbox"/> ok	<input type="checkbox"/> ok	<input type="checkbox"/> ok
APPROVED:	<input type="checkbox"/> YES	<input type="checkbox"/> YES	<input type="checkbox"/> YES	<input type="checkbox"/> YES
	<input type="checkbox"/> NO	<input type="checkbox"/> NO	<input type="checkbox"/> NO	<input type="checkbox"/> NO



**YEARS FROM PURCHASE**



	12	13	14	15
A. Leak test air bag:	<input type="checkbox"/> ok	<input type="checkbox"/> ok	<input type="checkbox"/> ok	<input type="checkbox"/> ok
- valve	<input type="checkbox"/> ok	<input type="checkbox"/> ok	<input type="checkbox"/> ok	<input type="checkbox"/> ok
B. Vizualni pregled:				
- no surface irregularities	<input type="checkbox"/> ok	<input type="checkbox"/> ok	<input type="checkbox"/> ok	<input type="checkbox"/> ok
- no surface irregularities	<input type="checkbox"/> ok	<input type="checkbox"/> ok	<input type="checkbox"/> ok	<input type="checkbox"/> ok
- no surface irregularities	<input type="checkbox"/> ok	<input type="checkbox"/> ok	<input type="checkbox"/> ok	<input type="checkbox"/> ok
APPROVED:	<input type="checkbox"/> YES	<input type="checkbox"/> YES	<input type="checkbox"/> YES	<input type="checkbox"/> YES
	<input type="checkbox"/> NO	<input type="checkbox"/> NO	<input type="checkbox"/> NO	<input type="checkbox"/> NO

DATE OF CHECK-UP:

CHECKED BY:



## CHECK-UP SHEET

### AIR BAGS 8 bar

TYPE:

SERIAL NO.:

Pressure test with water 12 bar

Duration 10 minutes (minimum)

ok

Pressure test with air 8 bar

ok

Leak test - air bag

ok

- connections

ok

Visual check: - no surface irregularities

ok

- no irregularities on edges

ok

Label: - even

ok

- undamaged

ok

Serial number levelled

ok

APPROVED:

YES

NO

DATE OF CHECK-UP:

CHECKED BY:



### CERTIFICATE OF CONFORMITY

**SAVATECH d.o.o. declares herewith that the high-pressure air bags of the series SLK, made of Kevlar cord and high-pressure air bags of the series SLS made of steel cord are in conformity with the standard prEN 13721 and comply with the provisions of the ISO 9001 and ISO 14001 standards.**

**SAVATECH**  
Iružba za proizvodnjo in trženje  
gumenotehničnih proizvodov  
in pnevmatike, d.o.o.  
Kranj, Škofjska c. 6

*[Handwritten signature]*



#### Environmental Protection Product

Savska c. 20 a, 4000 Kranj, Slovenia  
Tel.: +386 4 2066 388, Fax: +386 4 2066 390

**Savatech, d.o.o.**  
Industrial al Rubber and Tyres

